



**MosTeknorot.ru**

**Детали карданных валов**

**08.08.2022**

---

Телефон: 8 (800) 775 01 46  
WWW: [www.mosteknorot.ru](http://www.mosteknorot.ru)  
E-mail: [autopodveska@mail.ru](mailto:autopodveska@mail.ru)



# Содержание

Подвесные подшипники <3,5т.: Alfa Romeo.....	3
Audi .....	3
BMW .....	6
Chrysler .....	7
Chevrolet .....	8
Fiat .....	8
Ford .....	8
Gaz .....	9
Honda .....	10
Hyundai/Kia .....	10
Iveco .....	10
Jaguar .....	11
Jeep .....	12
Land Rover .....	12
Mazda .....	13
Mercedes .....	14
Mitsubishi .....	17
Nissan .....	17
Opel .....	18
Porsche .....	18
Renault .....	19
Ssang Yong .....	19
Suzuki .....	20
Toyota .....	20
Volkswagen .....	21
Volvo .....	22
Муфты эластичные .....	23
Пыльники крестовины кардана.....	23
Крестовины F.B.Cardan.....	25
Крестовины Sicit .....	26
Вилка - фланец Duster.....	28
Вилка - фланец Sprinter.....	29
Подвесные подшипники 3,5т> : BMC-CHRYSLER-DAF-FIAT-IVECO-VOLVO.....	29
Ford CARGO .....	30
MAN — IVECO .....	30
MERCEDES TRUCK .....	31
MITSUBISHI TRUCK .....	32
RENAULT TRUCK .....	32
SCANIA TRUCK .....	33

Подвесные подшипники <3,5т: Alfa Romeo

	<b>PP-4655</b>
	55519705
	Подшипник подвесной
	30x15x170 mm
ALFA ROMEO 156 Q4 4WD 00-	

Audi

	<b>PP-4603</b>
	8A0521101J
	Подшипник подвесной
	30x15x133 H:44 mm
Audi 80/90 B2-B4/S2 Quattro 4x4	

	<b>PP-4615</b>
	8D0521113G
	Подшипник подвесной
	30x15x180 H:69 mm
Audi 100-200/ A6-C4/ 82-97 Quattro 4x4	

	<b>PP-4618</b>
	4A0521101C
	Подшипник подвесной
	30x15x180 H:75 mm
Audi 100-200/ A6-C4/ 82-97 Quattro 4x4	

	<b>PP-4708</b>
	4G0521101C-E-F-G
	Подшипник подвесной
	30x15x227 H:102 mm
Audi Quattro 4x4 - A7	

	<b>PP-4709</b>
	4H0521101B
	Подшипник подвесной
	30x15x277 H:125 mm
Audi Quattro 4x4 - A8	

	<b>PP-4707</b>
	4E0521101K
	Подшипник подвесной
	30x15x188 H:59 mm
Audi Quattro 4x4	

	<b>PP-4548</b>
	4D0521113G
	Подшипник подвесной
	30x15x187 H:39 mm
Audi Quattro 4x4	

	<b>PP-4550</b>
	4B0521113
	Подшипник подвесной
	30x15x241 H:105 mm
Audi Quattro 4x4	

	<b>PP-4549</b>
	8D0521113 8D0521113G
	Подшипник подвесной
	30x15x229 H:85 mm
Audi A4 / B5 1995-2001 Quattro 4x4	

	<b>PP-4614</b>
	8E0521101AB 8E0521101P
	Подшипник подвесной
	30x15x229 H:85 mm
Audi A4 S4/C4 2001-09 Quattro 4x4	

	<b>PP-4634</b>
	8T0521101P
	Подшипник подвесной
	30x15x227 H:116 mm
Audi A5 Quattro 4x4	

	<b>PP-4616</b>
	4Z7521101N
	Подшипник подвесной
	30x15x241 H:82 mm
Audi A6 Allroad 2,5 TD 2000-05 Quattro 4x4	

	<b>PP-4624</b>
	4A0521101B
	Подшипник подвесной
	30x15x176 H:66 mm
Audi A6 C4 1994-1997 Quattro 4x4	

	<b>PP-4617</b>
	4F0521101E
	Подшипник подвесной
	30x15x227 H:71 mm
Audi A6 C6 2000-08 Quattro 4x4	

	<b>PP-4633</b>
	4F0521101H
	Подшипник подвесной
	30x15x227 H:69 mm
Audi A6 RS Quattro 4x4	

	<b>PP-4683</b>
	4K0521101B
	Подшипник подвесной
	30x15x277 mm
Audi A7	

	<b>PP-4680</b>
	4N0521101
	Подшипник подвесной
	30x15x190 mm
Audi A8	

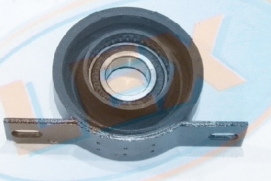
	<b>PP-4604</b>
	4D0521101R 4D0521113 4D8KE151 4D2KE151
	Подшипник подвесной
	30x15x130 H:41 mm
Audi A8 S8 Quattro 4x4	

	<b>PP-4629</b>
	8E0521101P
	Подшипник подвесной
	30x15x229 H:85 mm
Audi RS4 Quattro 4x4	

	<b>PP-4628</b>
	4F0521101F
	Подшипник подвесной
	30x15x227 H:71 mm
Audi RS6 Quattro 4x4	

	<b>PP-4554</b>
	5N0521101E 5N0521101C 5N0521101H 2153124300
	Подшипник подвесной
	30x19 mm
Audi Q3/VW Tiguan 4x4	

	<b>PP-4623</b>
	5N0521101C VWCB-TIG
	Подшипник вкладыш
	30x15 mm
Audi Q3/VW Tiguan 4x4	

	<b>PP-4681</b>
	80A521101b
	Подшипник подвесной
	30x15x212 mm
Audi Q5	

	<b>PP-4627</b>
	8R0521101D 8R0521102E 8R0521102D 8R0521102J
	Подшипник подвесной
	30x15x227 mm
Audi Q5 2009- Quattro 4x4	

	<b>PP-4532</b>
	7L0521102G 38548 PSB1060 VWCB-TOUARX
	Подвесной подшипник
	30x19x75 mm
Audi Q7 2005-09 /Touareg /Cayenne	

	<b>PP-4538</b>
	7L8521102L 7L8521102F 7L8521102M
	Подшипник подвесной
	30x19 mm
Audi Q7 2009-	

	<b>PP-4649</b>
	4M0521101Q
	Подшипник подвесной
	30x15 mm
Audi Q7 New	

	<b>PP-4632</b>
	8j0521101K
	Подшипник подвесной
	30x13 mm
Audi TT Quattro 4x4	

BMW

	<b>PP-4583</b>
	26127526631 27474 AS.240
	Подшипник подвесной
	30x13x160 mm
BMW 1 E81-84-87-88/5 E90-93/6 E64	

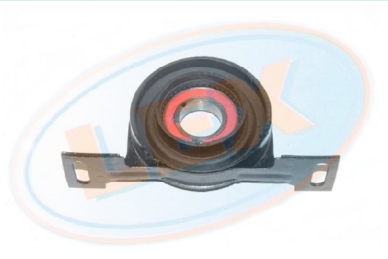
	<b>PP-4569</b>
	26121227660 22297
	Подшипник подвесной
	30x13x160 H:40 mm
BMW 3 E36/7 E38	

	<b>PP-4578</b>
	26121229682 21142
	Подшипник подвесной
	30x13x124 mm
BMW 3 E46	

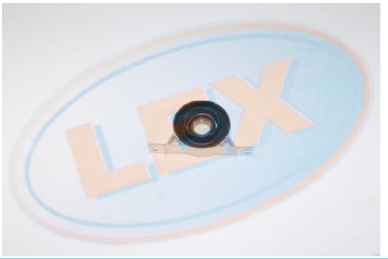
	<b>PP-4568</b>
	26127501257 26121229492 14919 PSB1013
	Подшипник подвесной
	30x13x160 H:42 mm
BMW 3 E46/Z4 99-09	

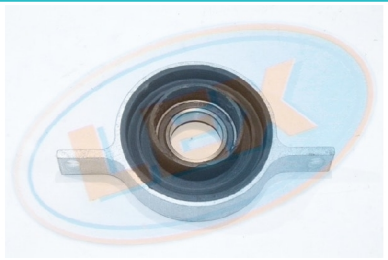
	<b>PP-4609</b>
	26127526632 27473
	Подшипник подвесной
	35x14x160 mm
BMW 3 E90/91/92/93	

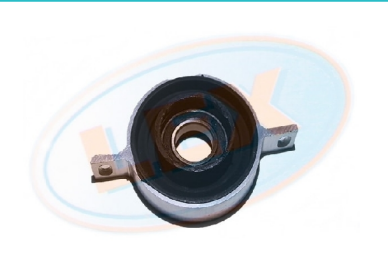
	<b>PP-4650</b>
	26127564694
	Подшипник подвесной
	30x13x145 mm
BMW 5 2010- F07/10/11	

	<b>PP-4567</b>
	26121226731 AS.240 01846 PSB1011
	Подшипник подвесной
	30x13x160 mm
BMW 5 E34/3 E36	

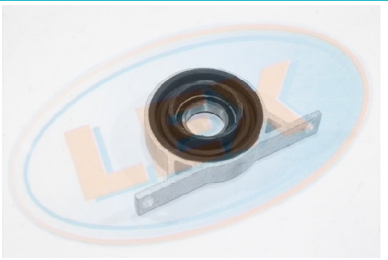
	<b>PP-4582</b>
	26127521856 26316
	Подшипник подвесной
	35x14x160 mm
BMW 5 E60-61/6 E63-64	

	<b>PP-4584</b>
	26127521855 AS.244 26265
	Подшипник подвесной
	30x13x160 mm
BMW 5 E60-61/6 E63-64/3 E83	

	<b>PP-4653</b>
	26122284496
	Подшипник подвесной
	35x14x145 mm
BMW 5(M5)/6(M6) 2010- F07/10/12/13	

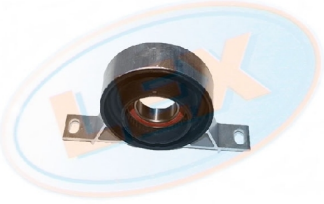
	<b>PP-4659</b>
	26122282496
	Подшипник подвесной
	35x14x160 H:42 mm
BMW 5(M5)/6(M6) 2010- F07/10/12/14	

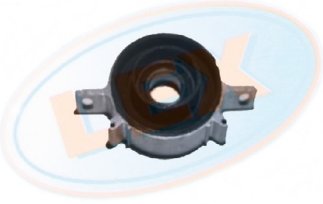
	<b>PP-4652</b>
	26127599802
	Подшипник подвесной
	30x13x145 mm
BMW 5/6 2010- F07/10/12/13	

	<b>PP-4651</b>
	26127564695
	Подшипник подвесной
	35x14x145 mm
BMW 5/7 2010- F07/10/12/13/F1..	

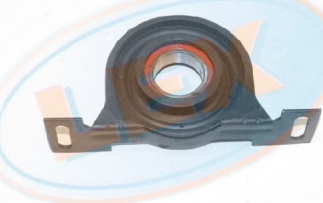
	<b>PP-4570</b>
	26121227997 22298
	Подшипник подвесной
	35x14x160 H:40 mm
BMW 7 E38 730d-750i	

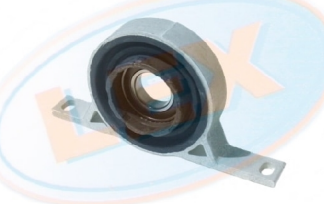
	<b>PP-4642</b>
	26127525966 30635
	Подшипник подвесной
	30x13x176 mm
BMW 7 E65/66	

	<b>PP-4547</b>
	26121229726 26127507740 23533 AS.243
	Подшипник подвесной
	30x13x130 mm
BMW X5 E53 SAV 3.0d M57	

Chrysler

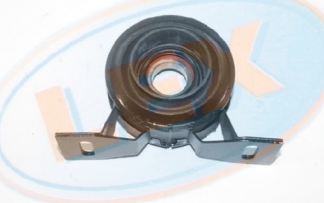
	<b>PP-4557</b>
	04641 899AA
	Подшипник подвесной
	30x13 mm
Chrysler Grand Voyager	

	<b>PP-4694</b>
	05161435AA
	Подшипник подвесной
	30x13x185 mm
Chrysler Voyager	

Chevrolet

	<b>PP-4577</b>
	0446073 20781756 96624771 4807201
	Подшипник подвесной
	30x13x194 mm
Chevrolet Captiva / Opel Frontera	

Fiat

	<b>PP-4611</b>
	808682 55193595 552221070 10179037
	Подшипник подвесной
	30x15x138 mm
Fiat New Panda 4x4 2006-	

	<b>PP-4631</b>
	71768334 27100-79J01
	Подшипник подвесной
	25x15 mm
Fiat Sedichi /Suzuki SX4	

	<b>PP-4660</b>
	K05157005AE
	Подшипник подвесной
	30x13 mm
Fiat Freemont	

Ford

	<b>PP-4516</b>
	1510905 8C114826AA FTR 6751 YM 44865
	Подшипник подвесной
	35x14x144 mm
Ford Transit V347	

	<b>PP-4517</b>
	6163548 88VB4826AA BSG 30-710-001 PSB1109
	Подшипник подвесной
	30x13x140 mm
Ford Transit 1978-1992 2,4/2,5	



	<b>PP-4518</b>
	7239265 95VB4826AA 4104708 BSG 30-710-002
	Подшипник подвесной
	30x13x144 mm
Ford Transit 1992-IV 184	

	<b>PP-4533</b>
	6635542 92VB4826CA 4104708 BSG 30-710-002
	Подшипник подвесной
	30x13x144 mm
Ford Transit 1992-2000 T15	

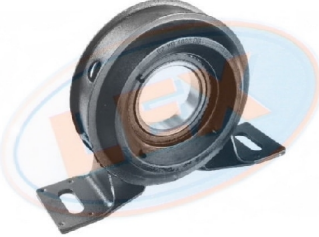
	<b>PP-4551</b>
	6649122 92VB4826BA BSG30-710-003 18301
	Подшипник подвесной
	45x16x144 mm
Ford Transit 1994-2000 TR15 Turbo	

	<b>PP-4527</b>
	4110249 SA02-25-310 XM344826AA P030-25-310
	Подшипник подвесной
	28x16x164 mm
Ford Ranger 2WD/Mazda B 2200-2500	

	<b>PP-4558</b>
	SA68-25-300
	Подшипник подвесной
	35x14x181 mm
Ford Ranger 4WD Turbo /MAZDA BT-50 06-	

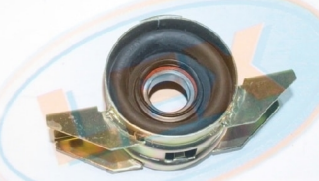
	<b>PP-4556</b>
	715F8594BA 71BG4826DB
	Подшипник подвесной
	30x13x150 mm
Ford TAUNUS 1,6-2,0	

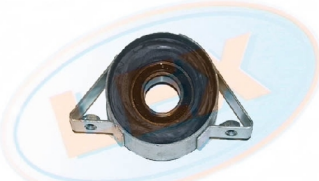
	<b>PP-4661</b>
	5218816
	Подшипник подвесной
	30x13x58 M8x1,25mm
Ford Kuga2	

	<b>PP-4662</b>
	1541780
	Подшипник подвесной
	30x13x116 M8x1,25mm
Ford Kuga	

Gaz

	<b>PP-4713</b>
	A21R-03517-05.99
	Подшипник подвесной
	35x17x170 mm
Gaz Next Tirsan	

Honda

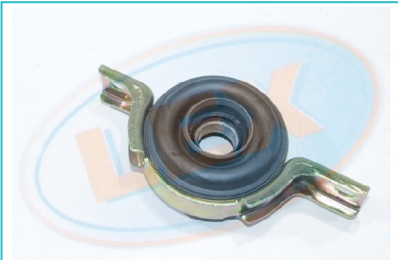
	<b>PP-4586</b>
	40520-S10-000 40520S10003 40100-SXS-A01 CBHC
	Подшипник подвесной
	25x12x170 mm
Honda CRV 1996-2000	

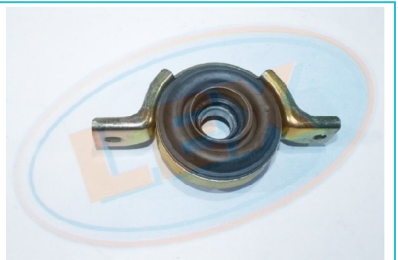
	<b>PP-4587</b>
	40100-S9A-J01 40100S9AJ01 029402T CBHC2
	Подшипник подвесной
	25x12x160 mm
Honda CRV 2002>2006	

Hyundai/Kia

	<b>PP-4685</b>
	495751u000
	Подшипник подвесной
	30x13 mm
Hyundai Santa Fe	

	<b>PP-4675</b>
	49575-2E000
	Подшипник подвесной
	28x16x179 mm
Hyundai Tusc 06-10	

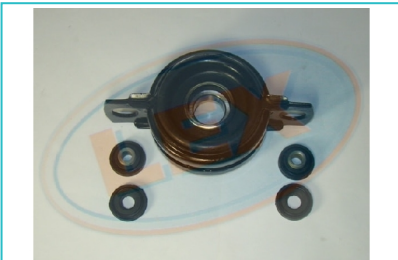
	<b>PP-4525</b>
	49130-4A000 49130-26000 MB154199 G90501BTA
	Подшипник подвесной
	30x16x162 mm
Hyundai H1/Santa Fe/Starex/Tuscan	

	<b>PP-4684</b>
	0k02f25310
	Подшипник подвесной
	25x15x165 mm
Kia Sportage	

Iveco

	<b>PP-4521</b>
	93156460 925013 284.014 2701.00
	Подшипник подвесной
	45x19x168 mm
Iveco Daily II -2000	

	<b>PP-4521.1</b>
	93156460 284.014 2703.00
	Подшипник подвесной
	45x16x168 mm
Iveco Daily II -2000	

	<b>PP-4605</b>
	994167 93158202 284.025
	Подшипник подвесной
	40x27x168 mm
Iveco Turbodayly (-96) 35.12/Zeta 50.9	

	<b>PP-4572</b>
	42536526 9984261 284.011 2700.00
	Подшипник подвесной
	35x25x168 mm
Iveco New Daily 30.8/Zeta 50.9/Turbozeta	

	<b>PP-4526</b>
	42530546 42535254 284.053 2703.00
	Подшипник подвесной
	40x22x170 mm
Iveco Daily III 06-/Iveco Daily City 2000 35S8	

	<b>PP-4585</b>
	42530546 42535254 284.053 2703.00
	Подшипник подвесной
	40x22x170 mm
Iveco Daily III 06-/Iveco Daily City 2000 35S8	

Jaguar

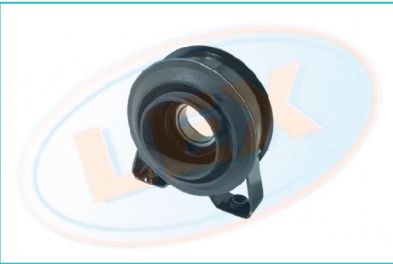
	<b>PP-4612</b>
	EBC 9040 JLM1542
	Подшипник подвесной
	30x13 mm
Jaguar XJ6/XJ5	

	<b>PP-4613</b>
	4X434602BB
	Подшипник подвесной
	65x18 mm
Jaguar X-Type 2001-2010	

	<b>PP-4622</b>
	XR850358 3180-3017 BRGJ6
	Подшипник подвесной
	30x13x169 mm
Jaguar S-Type 1997-2007	

Jeep

	<b>PP-4677</b>
	P68242641AA
	Подшипник передний
	30x15 mm
Jeep Cherokee 14-	

	<b>PP-4678</b>
	P68242641AA
	Подшипник задний
	30x15 mm
Jeep Cherokee 14-	

	<b>PP-4692</b>
	P521 23629 AA
	Подшипник подвесной
	30x13x160 mm
Jeep Grand Cherokee 2011-2021	

Land Rover

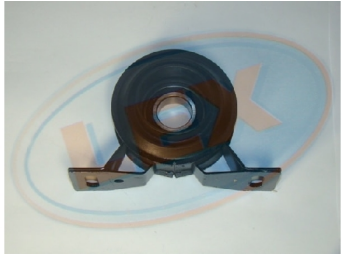
	<b>PP-4514</b>
	TOQ 000010 TOQ000040 AS.208 PSB1056
	Подшипник подвесной
	30x15x138 mm
Land Rover Freelander	

	<b>PP-4530</b>
	TOQ 000010 TOQ000040 AS.207 PSB1056
	Подшипник подвесной
	30x13x138 mm
Land Rover Freelander	

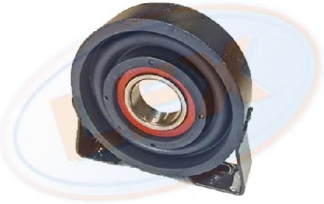
	<b>PP-4645</b>
	LR006959
	Подшипник подвесной
	30x13 mm
Land Rover Freelander II	

	<b>PP-4535</b>
	TVB 500400 AS.248
	Подшипник подвесной
	30x15x161 mm
Range Rover L322 2002-09	

	<b>PP-4536</b>
	TVB500360 AS.249 LRCB-DIII
	Подшипник подвесной
	30x15x130 H:57 mm
Range Rover /Sport 2004-11/Land Rover Discovery III	

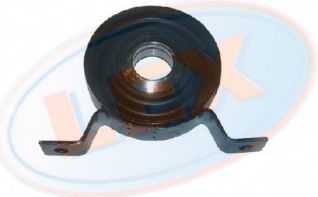
	<b>PP-4537</b>
	TVB500390 AS.250
	Подшипник подвесной
	30x15x130 H:65 mm
Range Rover Sport	

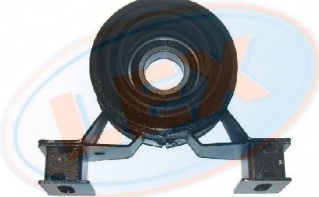
	<b>PP-4539</b>
	TOQ000060 LRCB-FLI
	Подшипник подвесной
	30x15x138 mm
Range Rover / Land Rover Freelander 2002-06	

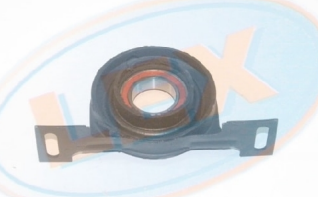
	<b>PP-4555</b>
	TOQ000050
	Подшипник подвесной
	35x14x160 H:40 mm
Range Rover / Freelander	

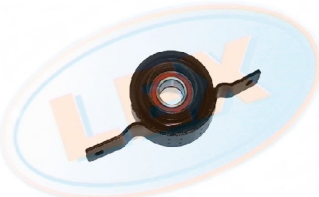
	<b>PP-4664</b>
	LR082554
	Подшипник подвесной
	30x15x201 mm
Range Rover 13-	

Mazda

	<b>PP-4527</b>
	4110249 SA02-25-310 XM344826AA P030-25-310
	Подшипник подвесной
	28x16x164 mm
Mazda B 2200-2500 2WD/Ford Ranger	

	<b>PP-4608</b>
	P04725310
	Подшипник подвесной
	25x15 mm
Mazda	

	<b>PP-4571</b>
	SA0225310
	Подшипник подвесной
Mazda B2200	

	<b>PP-4691</b>
	KG03-25-100D 7T4Z-4R60-2A
	Подшипник подвесной
	30x13x220 mm
Mazda CX-9 / Ford Edge	

Mercedes

	<b>PP-4672</b>
	a2044102281
	Подшипник подвесной
	30x13x181 mm
Mercedes GL	

	<b>PP-4699</b>
	1644102302
	Подшипник подвесной
	30x13x161 mm
Mercedes M Class	

	<b>PP-4552</b>
	A1634100010 24782
	Подшипник комплект
	30x13x98 mm
Mercedes ML-Class W163	

	<b>PP-4705</b>
	Подшипник подвесной
	30x13 mm
Mercedes NEW VITO	

	<b>PP-4520</b>
	A6394100681 A6394100281 BSG 60-710-012 32710
	Подшипник задний
	30x13x148 mm
Mercedes Vito W639	

	<b>PP-4522</b>
	A6394100481 A6394100081 BSG 60-710-013 32709
	Подшипник передний
	30x13x148 mm
Mercedes Vito W639	

	<b>PP-4626</b>
	A6394100581
	Подшипник задний
	32x13x148 mm
Mercedes Vito W639 115 CDI 2,2 АКПП 4x4 2007	

	<b>PP-4706</b>
	6394100581 639 410 0181
	Подшипник подвесной
	30x13x148 H:65 mm
Mercedes Vito - REAR +пыльники	

	<b>PP-4656</b>
	A6394100581
	Подшипник передний
	32x13 mm
Mercedes Vito 115 CDI 2,2 АКПП 4x4 2007	

	<b>PP-4667</b>
	A4474100600
	Подшипник передний
	30x13x205/265 H:12 mm
Mercedes Vito W447 14-	

	<b>PP-4668</b>
	A4474101206
	Подшипник задний
	30x13x148 H:44 mm
Mercedes Vito W447 14-	

	<b>PP-4673</b>
	A4474103100
	Подшипник подвесной
	30x13x205/265 H:40 mm
Mercedes Vito 15-	

	<b>PP-4674</b>
	A4474103300
	Подшипник подвесной
	30x13x148 H:40 mm
Mercedes Vito 15-	

	<b>PP-4702</b>
	2044100981 204 410 15 81
	Подшипник подвесной
	30x13x182 mm
Mercedes W204	

	<b>PP-4703</b>
	2044101081 204 410 12 81
	Подшипник подвесной
	30x13x182 mm
Mercedes W204	

	<b>PP-4704</b>
	2054106501 2054100881
	Подшипник подвесной
	30x13x132 mm
Mercedes W205	

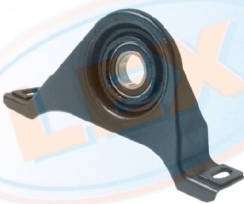
	<b>PP-4643</b>
	A2104101881 10209 PSB1007
	Подшипник подвесной
	25x12x208 mm
Mercedes W210 1995-03	

	<b>PP-4700</b>
	2114100181
	Подшипник подвесной
	30x13x209 mm
Mercedes W211	

	<b>PP-4701</b>
	2114100381
	Подшипник подвесной
	30x13x209 mm
Mercedes W211	

	<b>PP-4581</b>
	A2114100181 30934
	Подшипник подвесной
	30x13x187 mm
Mercedes W211 220-C219	

	<b>PP-4665</b>
	A2124103416
	Подшипник подвесной
	30x13x182 H:77 mm
Mercedes W211-212	

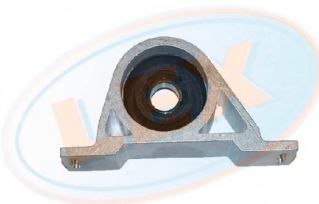
	<b>PP-4666</b>
	A2114105081
	Подшипник подвесной
	30x13 mm
Mercedes W211-212	

	<b>PP-4657</b>
	A2214108106
	Подшипник подвесной
	30x13 mm
Mercedes W221	

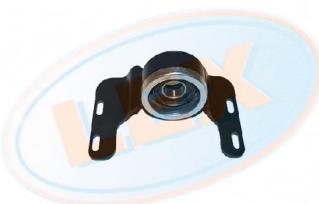
	<b>PP-4663</b>
	A2214108106
	Подшипник подвесной
	30x13 mm
Mercedes W221	

	<b>PP-4658</b>
	A2214105081
	Подшипник подвесной
	30x13x207 H:65,50 mm
Mercedes W221/S CLASS	

	<b>PP-4679</b>
	A2124103416
	Подшипник подвесной
	30x9x292/294 mm
Mercedes W246/C117/W176/X156	

	<b>PP-4519</b>
	A9064100281 5154101782 BSG 60-710-005 31851
	Комплект с пыльником
	47x21x194 H:73 mm
Mercedes Sprinter W906 /Crafter 2006-	

	<b>PP-4519.1</b>
	A9064100281 BSG 60-710-005 31851
	Подшипник задний
	47x21x194 H:73 mm
Mercedes Sprinter W906 /Crafter 2006-	

	<b>PP-4541</b>
	A9014110312 A9014110412 A9034100010 BSG 60-710-003
	Подшипник подвесной
	45x19x194 mm
Mercedes Sprinter W901/VW LT II 28-35	

	<b>PP-4541.1</b>
	A9014110312 A9014110412 A9034100010 BSG 60-710-003
	Комплект подшипника
	45x19x194 mm
Mercedes Sprinter W901/VW LT II 28-35	



НАБЕРХ

Mercedes

	<b>PP-4540</b>
	A9064100381 A9064100181 5154101782 BSG 60-710-004
	Подшипник передний
	47x21x194 H:68 mm
Mercedes Sprinter W906 /Crafter 2006-	

	<b>PP-4540.1</b>
	A9064100381 5154101782 BSG 60-710-004 31852
	Комплект подшипника
	47x21x194 H:68 mm
Mercedes Sprinter W906 /Crafter 2006-	

Mitsubishi

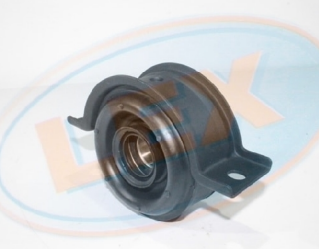
	<b>PP-4559</b>
	MR580647 MR580648 AS.221 MCB-KB4
	Подшипник подвесной
	30x16x160 mm
Mitsubishi L 200 kb4t 4wd 2006-	

	<b>PP-4524</b>
	MB154706 MR534956 MR357998 AS.174
	Подшипник подвесной
	30x16x160 mm
Mitsubishi Pajero 88-95, L200/300	

	<b>PP-4697</b>
	3401A022 3401A458
	Подшипник подвесной
	25x12 mm
Mitsubishi Outlander/ASX, PSA 4007 /C-Crosser	

Nissan

	<b>PP-4528</b>
	37521-6P026 37521-W1026 G91004BTA NCB-001
	Подшипник подвесной
	30x16 mm
Nissan D22/Nissan Qashgai/Xtrail	

	<b>PP-4529</b>
	37520-ZL40A 37522-JR60A AS.182
	Подшипник подвесной
	45x19x167 mm
Nissan NAVARA	

Opel

	<b>PP-4562</b>
	04 58 014 90470670 01857
	Подшипник подвесной
	30x13 mm
Opel Omega B	

	<b>PP-4561</b>
	04 58 009 90343676 AS.251 08173
	Подшипник подвесной
	30x13x96 mm
Opel Omega A	

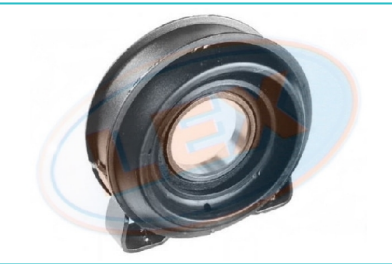
	<b>PP-4545</b>
	1340501 AS.191 22595
	Подвесной подшипник
	45x16x80 mm
Opel Frontera A /Volvo 740 1985-92/S90	

	<b>PP-4577</b>
	20781756 96624771 446073 4807201
	Подшипник подвесной
	30x13x194 mm
Opel Frontera B /Antara/ Chevrolet Captiva	

	<b>PP-4654</b>
	22947024
	Подшипник подвесной
	30x15x237 mm
OPEL МОККА	

Porsche

	<b>PP-4648</b>
	97042101153
	Подшипник подвесной
	30x19 mm
Porsche Panamera	

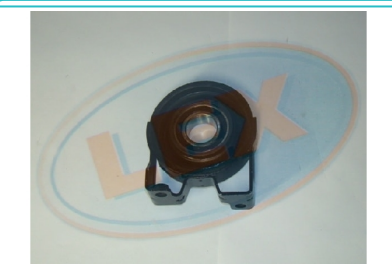
	<b>PP-4532</b>
	7L0521102G 38548 PSB1060 VWCB-TOUARX
	Подшипник подвесной
	30x19x75 mm
Porsche Cayenne/VW Touareg 4x4	

Renault

	<b>PP-4630</b>
	397740385R 37000 2820R
	Подшипник подвесной
	30x15x130 mm
<b>Renault Duster 4X4</b>	

	<b>PP-4630.1</b>
	397740385r
	Комплект подшипника
	30x15x130 mm
<b>Renault Duster</b>	

	<b>PP-4602</b>
	23561526920 АКК211404027 4485131
	Подшипник подвесной
	30x15x130 mm
<b>Renault Scenic /Kangoo 4x4</b>	

	<b>PP-4528</b>
	37000JY00A 370007622R 37521-W1026 G91004BTA
	Подшипник подвесной
	D110x51 (30x16) mm
<b>Renault Koleos 08-/Nissan Qashgai-Xtrail</b>	

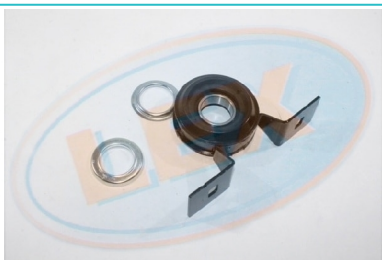
	<b>PP-4576</b>
	375252191R
	Комплект подшипника
	45x19x170 mm
<b>Renault Master III</b>	

Ssang Yong

	<b>PP-4689</b>
	33200-34000
	Подшипник подвесной
	30x13x138 mm
<b>SsangYong Korando III</b>	

	<b>PP-4670</b>
	3320009410
	Подшипник подвесной
	30x15 M12x1.26 mm
<b>Ssangyong Kyron</b>	

	<b>PP-4669</b>
	3320008120
	Подшипник подвесной
	30x15 M12x1.25 mm
Ssangyong Rexton	

Suzuki

	<b>PP-4631</b>
	71768334 27100-79J01
	Подшипник подвесной
	25x15 mm
Suzuki SX4/Fiat Sedici	

Toyota

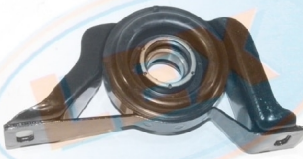
	<b>PP-4560</b>
	37230-42010 TCB-002
	Подшипник подвесной
	30x13x204 mm
Toyota RAV4 1997-2000	

	<b>PP-4564</b>
	37230-0K011
	Подшипник подвесной
	30x13x152 mm
Toyota Hilux 2x2 1997	

	<b>PP-4566</b>
	37230-0K021 37230-0K020 37230-0K030 TCB-025
	Подшипник подвесной
	30x13x152 mm
Toyota Hilux 4x4 2006-2011	

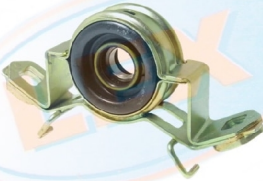
	<b>PP-4637</b>
	37230-35080 37230-35100 TCB-009
	Подшипник подвесной
	30x13x235,5 mm
Toyota 4Runner 1990-2002 /Hilux II Pick-up 1988-/ 4 WD	

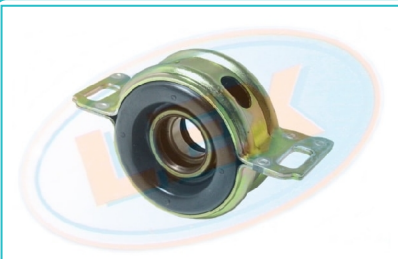
	<b>PP-4641</b>
	37230-26020 37230-35130 TCB-003
	Подшипник подвесной
	30x13x150 mm
Toyota Hilux / 4 Runner -2005	

	<b>PP-4687</b>
	37230-09030
	Подшипник подвесной
	32x17x180 H:8 mm
Toyota Hilux 2015> 4x4	

Volkswagen

	<b>PP-4712</b>
	1H0 521 349
	Подшипник подвесной
	30x13 mm
VW - GOLF IV/Octavia 4x4	

	<b>PP-4682</b>
	2k0521101n
	Подшипник подвесной
	30x13x188 mm
VW Caddy 4x4	

	<b>PP-4647</b>
	7M0521351B
	Подшипник подвесной
	30x13x255 mm
VW Sharan 4X4	

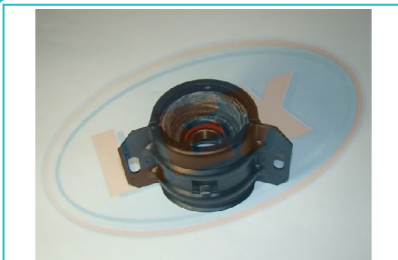
	<b>PP-4515</b>
	293521351 PSB1059
	Подшипник подвесной
	30x13 mm
VW LT 1975-1996	

	<b>PP-4621</b>
	3D0521101R
	Подшипник подвесной
	30x15x260 mm
VW Pheaton	

	<b>PP-4619</b>
	7H3521102A 7H1521102A
	Подшипник задний
	30x15x163 H:96,50 mm
VW T5 4x4	

	<b>PP-4620</b>
	7E0598349E 7E0598349B
	Подшипник передний
	30x15x149 H:59 mm
VW T5 4x4	

	<b>PP-4623</b>
	5N0521101C VWCB-TIG
	Подшипник вкладыш
	30x15 mm
VW Tiguan 4x4 /Audi Q3	

	<b>PP-4554</b>
	5N0521101E 5N0521101C 2153124300085 2153124300
	Подшипник подвесной
	30x19 mm
VW Tiguan 4x4 /Audi Q3	

	<b>PP-4676</b>
	7L0521102G
	Комплект подшипника
	30x19 mm
VW Touareg /Cayenne	

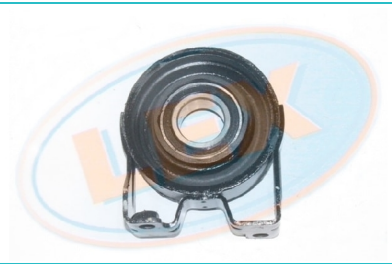
	<b>PP-4563</b>
	7L0521102G 10000089000
	Подшипник подвесной
	30x19 mm
VW Touareg	

	<b>PP-4625</b>
	7P6598575
	Подшипник подвесной
	35x14 mm
VW Touareg New 2010- 4x4	

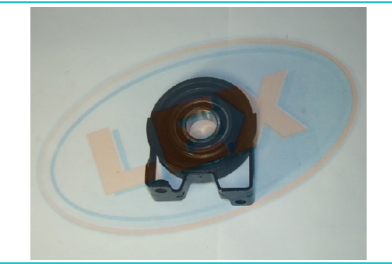
	<b>PP-4532</b>
	7L0521102G 38548 PSB1060 VWCB-TOUARX
	Подшипник подвесной
	30x19x75 mm
VW Touareg 4x4 /Porsche Cayenne	

	<b>PP-4646</b>
	2N0598351B
	Подшипник подвесной
	30x15x168 mm
VW Amarok	

Volvo

	<b>PP-4545</b>
	1340501 AS.191 22595
	Подшипник подвесной
	45x16x80 mm
Volvo 740 1985-92/S90 / Opel Frontera	

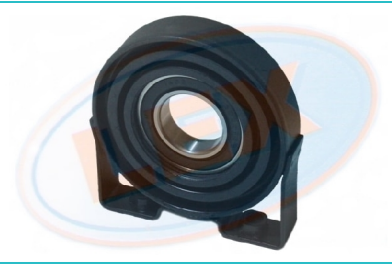
	<b>PP-4638</b>
	31256270 5115100281
	Подшипник подвесной
	30x13x57 H:57 M8x1.25 mm
Volvo S60/S70/V70/XC70 2000-	

	<b>PP-4639</b>
	9480702 5114100081
	Подшипник подвесной
	25x12x75 H:68 M8x1.25 mm
Volvo V70/S70/XC70 1997-00	

	<b>PP-4640</b>
	31256271
	Подшипник подвесной
	30x13x93 H:50 M8x1.25 mm
Volvo XC70 TURBO/ XC90 2000-08	

	<b>PP-4693</b>
	31492149
	Подшипник подвесной
	30x15 mm
VOLVO V90 2017-	

Муфты эластичные

	<b>PP-4575</b>
	4165078 2L1W4684AA 34961
	Муфта кардана
	D120 mm
Ford Transit V347	

	<b>PP-4644</b>
	TVF100010 TVF100110H
	Муфта кардана
	D95 mm
Land Rover Freelander	

	<b>PP-4580</b>
	370007837R
	Муфта кардана
	D120 mm
Renault Master III M9T 2010-	

	<b>PP-4579</b>
	7L0521403 23144 PSE5014 VWDS-TOUAR
	Муфта кардана
	D110 mm
VW Touareg 4x4	

Пыльники крестовины кардана

	<b>KK-6712</b>
	7L6521102Q
	Кожух передний
	D=94 d1=64,9 d2=27 H=34,5 h1=13,5 dO=*mm
VW Touareg	

	<b>KK-6713</b>
	5N0521101E
	Кожух передний
	D=91 d1=64,9 d2=23 H=36 h1=13,5 dO=*mm
VW Tiguan	

	<b>KK-6714</b>
	26111229524
	Кожух кардана
	D=108 d1=72 d2=24 H=28 h1=10 dO=94mm
BMW	

	<b>KK-6715</b>
	26117526822 2315-T4SA 701521391
	Кожух задний
	D=99,6 d1=67,8 d2=21 H=31 h1=10 dO=86mm
VW Touareg ,BMW X 5 E 53	

	<b>KK-6716</b>
	31216176 2715-XC90
	Кожух кардана
	D=85,8 d1=57,8 d2=18 H=31 h1=7 dO=74mm
VOLVO XC90	

	<b>KK-6717</b>
	31256271 2715-XC90SA
	Кожух кардана
	D=77,8 d1=51,5 d2=18 H=27,5 h1=7 dO=66mm
VOLVO XC90	

	<b>KK-6718</b>
	7H0521101
	Кожух кардана
	D=99,6 d1=67,8 d2=27 H=31 h1=21 dO=86mm
VW T5 Multivan 4x4	

	<b>KK-6719</b>
	26111225015
	Кожух кардана
	D=94,8 d1=63,3 d2=23 H=38 h1=10mm
BMW/Suzuki Grand Vit	

	<b>KK-6720</b>
	2710167J01
	Кожух кардана
	D=83,9 d1=64,9 d2=27 H=35 h1=13,3mm
Suzuki Grand Vit	

	<b>KK-6721</b>
	397740385r
	Кожух кардана
	D=70,0 d1=61,5 d2=23 H=39,7 h1=13mm
Renault Duster	

	<b>KK-6722</b>
	5218816
	Кожух кардана
	D=69,9 d1=51,5 d2=18 H=29 h1=13mm
Ford Kuga2	

	<b>KK-6723</b>
	TVB000090
	Кожух кардана
	D=92,2 d1=67,6 d2=25 H=29 h1=5,5mm
LAND ROVER Freelander I 98-06	



	<b>KK-6724</b>
	2H0521101H
	Кожух кардана
	D=84,0 d1=75,5 d2=35 H=11,5 h1=14mm
<b>VW Amarok/Touareg</b>	

Крестовины F.B.Cardan

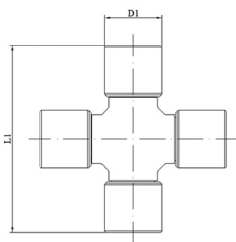
	<b>19557</b>
	19557 320003602R
	Крестовина кардан.вала
	F.B.Cardan 19x55,7 mm
<b>Renault Duster</b>	

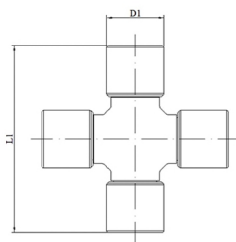
	<b>2252</b>
	2252 U019
	Крестовина кардан.вала
	F.B.Cardan 22x52 mm
<b>Renault Duster</b>	

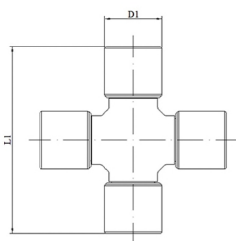
	<b>22575</b>
	22575 GUT24
	Крестовина кардан.вала
	F.B.Cardan 22x57,5 mm
<b>Toyota RAV 4 II (A20) 00- Lexus RX 300 350</b>	

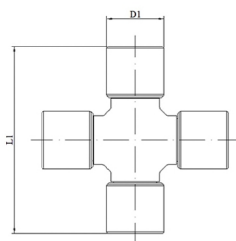
	<b>ST2456</b>
	ST2456 26208605866
	Крестовина кардан.вала
	F.B.Cardan 24x56 mm
<b>BMW F07</b>	

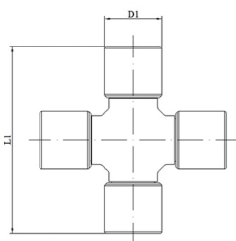
	<b>24625</b>
	24625 26117518304
	Крестовина кардан.вала
	F.B.Cardan 24x62,5 mm
<b>Volvo XC90/BMW X5/Qash/Kuga</b>	

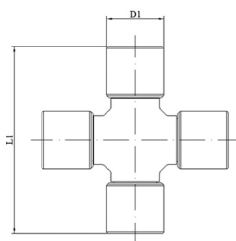
	<b>24645</b>
	24645 493002S000
	Крестовина кардан.вала
	F.B.Cardan 24x64,5 mm
<b>Hyundai IX35/Sportage/Tuscan</b>	

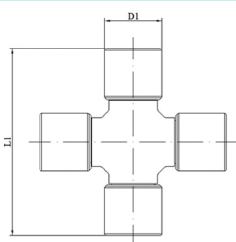
	<b>2488</b>
	2488 A9064100106
	Крестовина кардан.вала
	F.B.Cardan 24x88 mm
<b>Sprinter w906/Vito 638</b>	

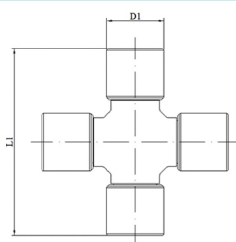
	<b>ST27745</b>
	ST27745 GU1100
	Крестовина кардан.вала
	F.B.Cardan 27x74,5 mm
<b>FORD TRANSIT, FIAT,RENAULT</b>	

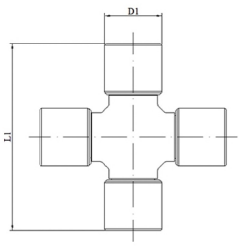
	<b>ST2780</b>
	ST2780 U178
	Крестовина кардан.вала
	F.B.Cardan 27x80 mm
<b>Mercedes-Benz Sprinter</b>	

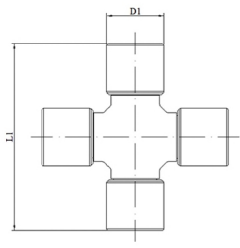
	<b>2788</b>
	2788 A9064103401
	Крестовина кардан.вала
	F.B.Cardan 27x88 mm
<b>Sprinter w906-909RUS/Vito/Sorento</b>	

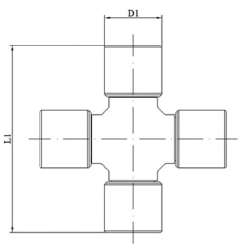
	<b>3092LL</b>
	3092LL 2100178
	Крестовина кардан.вала
	F.B.Cardan 30x92 mm
<b>Nissan Pathfinder</b>	

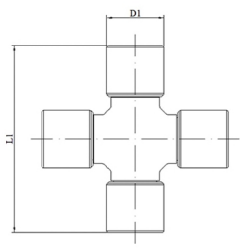
	<b>3188F1</b>
	3188F1 A9064102106
	Крестовина кардан.вала
	F.B.Cardan 31x88,2 mm
<b>MB Sprinter/VW-Crafter</b>	

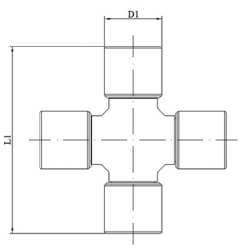
	<b>521472</b>
	521472 VKUA521472
	Крестовина кардан.вала
	F.B.Cardan 52x147,2 mm
<b>Iveco Strallis</b>	

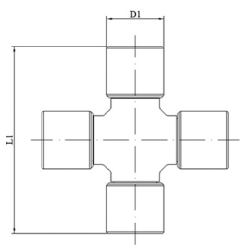
	<b>57144</b>
	57144 81391086051
	Крестовина кардан.вала
	F.B.Cardan 57x144 mm
<b>MAN F90/L2000/Iveco EuroTech/КамАЗ 6520</b>	

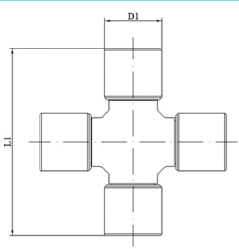
	<b>57152LL</b>
	57152LL 81393746003
	Крестовина кардан.вала
	F.B.Cardan 57x152 mm
<b>MAN</b>	

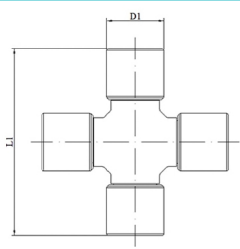
	<b>65172</b>
	65172 93156581
	Крестовина кардан.вала
	F.B.Cardan 65x172 mm
<b>Iveco 190.30-48. 240.30-48</b>	

Крестовины Sicit

	<b>ST1955</b>
	320003602R 320003602R
	Крестовина кардан.вала
	Sicit 19,05x55,5 mm
<b>Renault Duster</b>	

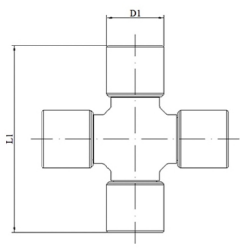
	<b>ST2257</b>
	gut24 gut24
	Крестовина кардан.вала
	Sicit 22x57 mm
<b>Toyota - Subaru</b>	

	<b>ST1310</b>
	26117518304 26117518304
	Крестовина кардан.вала
Sicit 24,06x62 mm	
Volvo XC90/BMW X5/Qash/Kuga	

	<b>ST1320</b>
	493002S000 493002S000
	Крестовина кардан.вала
Sicit 24,06x64 mm	
Hyundai IX35/Sportage/Tuscan	

	<b>ST1330</b>
	96624772 96624772
	Крестовина кардан.вала
Sicit 24,06x74,4 mm	
Captiva/Antara/Vito	

	<b>ST1340</b>
	A9064100106 A9064100106
	Крестовина кардан.вала
Sicit 24,09x88,1 mm	
Sprinter w906/Vito 638	

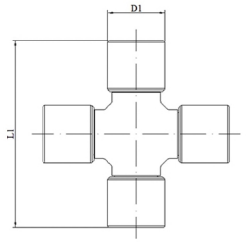
	<b>ST1300</b>
	26208605866 26208605866
	Крестовина кардан.вала
Sicit 24x56 mm	
BMW F07	

	<b>ST1190</b>
	A9064103401 A9064103401
	Крестовина кардан.вала
Sicit 27,08x88 mm	
Sprinter w906-909RUS/Vito/Sorento	

	<b>ST1180</b>
	371252X801 371252X801
	Крестовина кардан.вала
Sicit 27x74,61 mm	
Sprinter w901/Trans -00/Ter 2	

	<b>1180</b>
	3520997 3520997
	Крестовина кардан.вала
Sicit 27x76,4 mm	
Land Rover/Volvo	

	<b>ST1360MOD</b>
	491404A000 491404A000
	Крестовина кардан.вала
Sicit 27x80 mm	
Porter Tagaz/Santa FE	

	<b>1360</b>
	3311501000 3311501000
	Крестовина кардан.вала
Sicit 27x82 mm	
Hover/SSanYong/ML163/Tr-00	

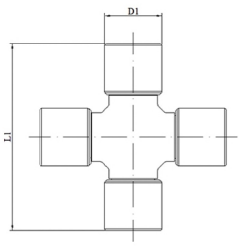
	<b>ST1210</b>
	U178 U178
	Крестовина кардан.вала
	Sicit 27x80 mm
Mercedes-Benz Sprinter	

	<b>20200</b>
	42541373 42541373
	Крестовина кардан.вала
	Sicit 30,18x81,8 mm
Daily IV	

	<b>4090</b>
	1835511 1835511
	Крестовина кардан.вала
	Sicit 30,18x92 mm
Ford Transit V347 мост	

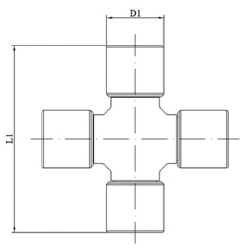
	<b>1500</b>
	42530886 42530886
	Крестовина кардан.вала
	Sicit 30,2x81,8 mm
Iveco	

	<b>1280</b>
	GU2050 GU2050
	Крестовина кардан.вала
	Sicit 30,24x106,3 mm
Daily V (106,3*30,18)/Isuzu/DAF	

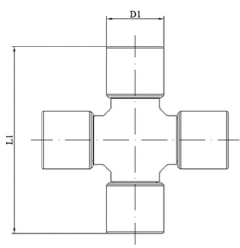
	<b>ST2240.10</b>
	A9064102106 A9064102106
	Крестовина кардан.вала
	Sicit 31x88,2 mm
MB Sprinter/VW-Crafter	

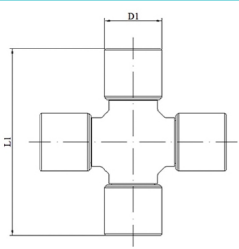
	<b>ST2240</b>
	A9064102106 A9064102106
	Крестовина кардан.вала
	Sicit 31x88,2 mm (кернение)
MB Sprinter/VW-Crafter	

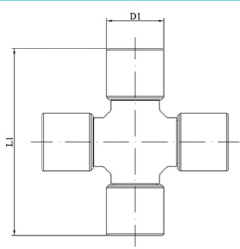
	<b>2890</b>
	7687250600160 7687250600160
	Крестовина кардан.вала
	Sicit 34,9x92 mm
Iveco	

Вилка - фланец Duster

	<b>TY0780000006</b>
	KN23861FY115
	Вилка карданного вала
	Sicit 23x61 mm
Renault Duster	

	<b>FY.078.994</b>
	1143CF10100
	Фланец кардан.вала
	Sicit
Renault Duster	

Вилка - фланец Sprinter

	<b>TY1000000002</b>
	4203TC00200
	Вилка карданного вала
Sicit 30,2x81,8 mm	
Mercedes-Benz Sprinter	

	<b>TY1000000006</b>
	TY6872070L
	Вилка приварная
Sicit 30.2x81.8 труба 76.2x2.4 h-72 mm	
Mercedes-Benz Sprinter	

	<b>TY1000000007</b>
	TY6872076L
	Вилка приварная
Sicit 30.2x81.8 труба 76.2x2.4 h-72 mm	
Mercedes-Benz Sprinter	

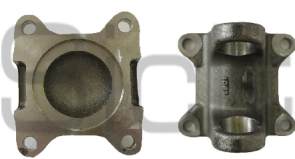
	<b>FY.100.996</b>
	4203CF02600
	Фланец кардан.вала
Sicit 30,2x81,8 mm	
Mercedes-Benz Sprinter	

Подвесные подшипники 3,5т> : BMC-CHRYSLER-DAF-FIAT-IVECO-VOLVO

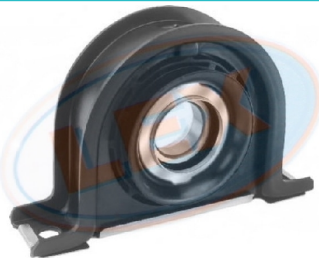
	<b>PP-4546</b>
	42536526 9984261 284.011 2700.00
	Подшипник подвесной
	35x17x168 mm
BMC - IVECO Daily - FIAT-CHRYSLER	

	<b>PP-4590</b>
	93157125
	Подшипник подвесной
	60x22x150 mm
BMC-DAF-IVECO	

	<b>PP-4591</b>
	93163689 284.023 2725.00 060.072
	Подшипник подвесной
	70x20x220 mm
BMC-DAF-IVECO -VOLVO	

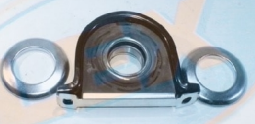
	<b>PP-4597</b>
	42536524 93163091 284.022 2711.00
	Подшипник подвесной
	55x18x194 mm
CHRYSLER-DAF-FIAT-FORD-IVECO-VOLVO	

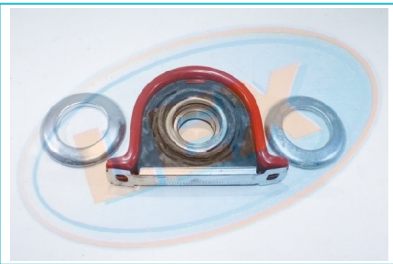
	<b>PP-4598</b>
	5000589888 4765838 4765836 4503320
	Подшипник подвесной
	50x20x194 mm
DAF-FIAT-Renault Midlum G210-290	

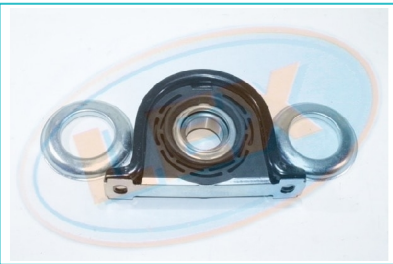
	<b>PP-4606</b>
	5000821936 93158251 284.027 4639052
	Подшипник подвесной
	45x27x193 mm
FORD-IVECO-Renault S130/Midlum	

Ford CARGO

	<b>PP-G3310</b>
	9C464712BA 93157125
	Подшипник подвесной
Ford CARGO 2524/3227/3230	

	<b>PP-G3310.1</b>
	9C464712BA 93157125
	Подшипник подвесной
Ford CARGO 2524/3227/3230	

MAN — IVECO

	<b>PP-4592</b>
	81394106013 284.042 AS.144 12360
	Подшипник подвесной
	65x23x230 mm
MAN	

	<b>PP-4599</b>
	81394106018 284.106 020.181
	Подшипник подвесной
	100x13 mm
MAN/Iveco	

	<b>PP-4600</b>
	81394106031 284.105 27261 020.213
	Подшипник подвесной
	85x13x220 mm
MAN/Iveco	

	<b>PP-4601</b>
	81394106020 32256 020.274
	Подшипник подвесной
	75x20x230 mm
MAN/Iveco	

MERCEDES TRUCK

	<b>PP-4534</b>
	A6014102110 A6014101710 011.179 06404
	Подшипник подвесной
	45x19x194 mm
Mercedes 207-209 / T1 1977- 1996	

	<b>PP-4553</b>
	A6014101710 A6014101510 011.179 06404
	Подшипник подвесной
	45x16x194 mm
Mercedes 207-209 / T1 1977- 1996	

	<b>PP-4543</b>
	A3104100822 A3104100922 07062
	Подшипник подвесной
	35x17x157 mm
Mercedes 309- 408- 508- 608-613	

	<b>PP-4607</b>
	A3854101722 A3854101622 011.178 03393
	Подшипник подвесной
	55x25x190 mm
Mercedes 355-099	

	<b>PP-4544</b>
	A3104100822 A3094100110 07062 BSG 60-710-006
	Подшипник подвесной
	30x19x157 mm
Mercedes 508	

	<b>PP-4542</b>
	A4604100222 A4604100910 02011 BSG 60-710-007
	Подшипник подвесной
	35x17x160 mm
Mercedes 609/668-673	

	<b>PP-4589</b>
	A3894100122 A6544100022 011.184 24657
	Подшипник подвесной
	60x22x245 mm
Mercedes ACTROS	

	<b>PP-4596</b>
	A9714110112
	Подшипник подвесной
	55x21 mm
Mercedes ACTROS	

	<b>PP-4588</b>
	A3954100622 A6554100022 011.181 22976
	Подшипник подвесной
	70x20x245 mm
Mercedes ACTROS 1633-4436/343-001	

	<b>PP-4594</b>
	A6564110012 011.276 26410
	Подшипник подвесной
	70x20x194 mm
Mercedes ACTROS 2540	

НАВЕРХ

MERCEDES TRUCK

	<b>PP-4595</b>
	A6544110012 011.275 38091
	Подшипник подвесной
	60x22 mm
Mercedes ACTROS/ Atego	

	<b>PP-4593</b>
	A3184101522
	Подшипник подвесной
	55x21x220 mm
Mercedes AXOR /ACTROS 2517-2521	

	<b>PP-4610</b>
	A6704110112 A9704110112 24511 BSG 60-710-010
	Подшипник подвесной
	45x19x160 mm
Mercedes New Atego	

	<b>PP-4523</b>
	A3814101522 A3814100920 03538
	Подшипник подвесной
	45x27x190 mm
Mercedes T2 VARIO	

MITSUBISHI TRUCK

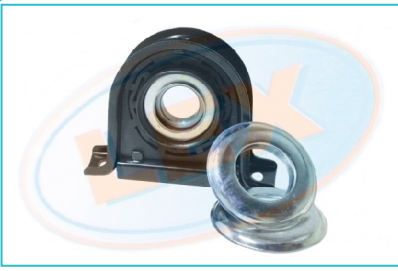
	<b>PP-4635</b>
	MB563204 MB000078
	Подшипник подвесной
	40x18 mm
Mitsubishi Canter FE.659 E/F	

RENAULT TRUCK

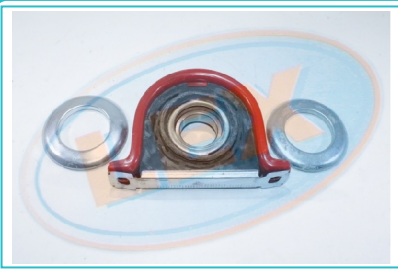
	<b>PP-4598</b>
	5000589888 4765838 4765836 4503320
	Подшипник подвесной
	50x20x194 mm
Renault Midlum G210-290//Iveco/Ford	

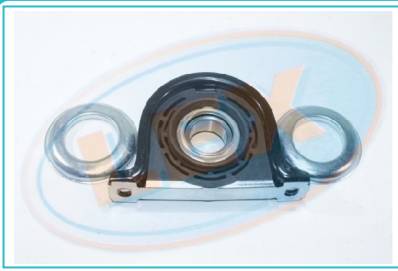
	<b>PP-4606</b>
	5000821936 93158251 4639052 284.027
	Подшипник подвесной
	45x27x193 mm
Renault S130/Midlum//Iveco/Ford	



SCANIA TRUCK

	<b>PP-4531</b>
	1387764 40509 040.189
	Подшипник подвесной
	60x22 mm
Scania	